

# Electrical Schematic, Lower Controls, Perkins Engine

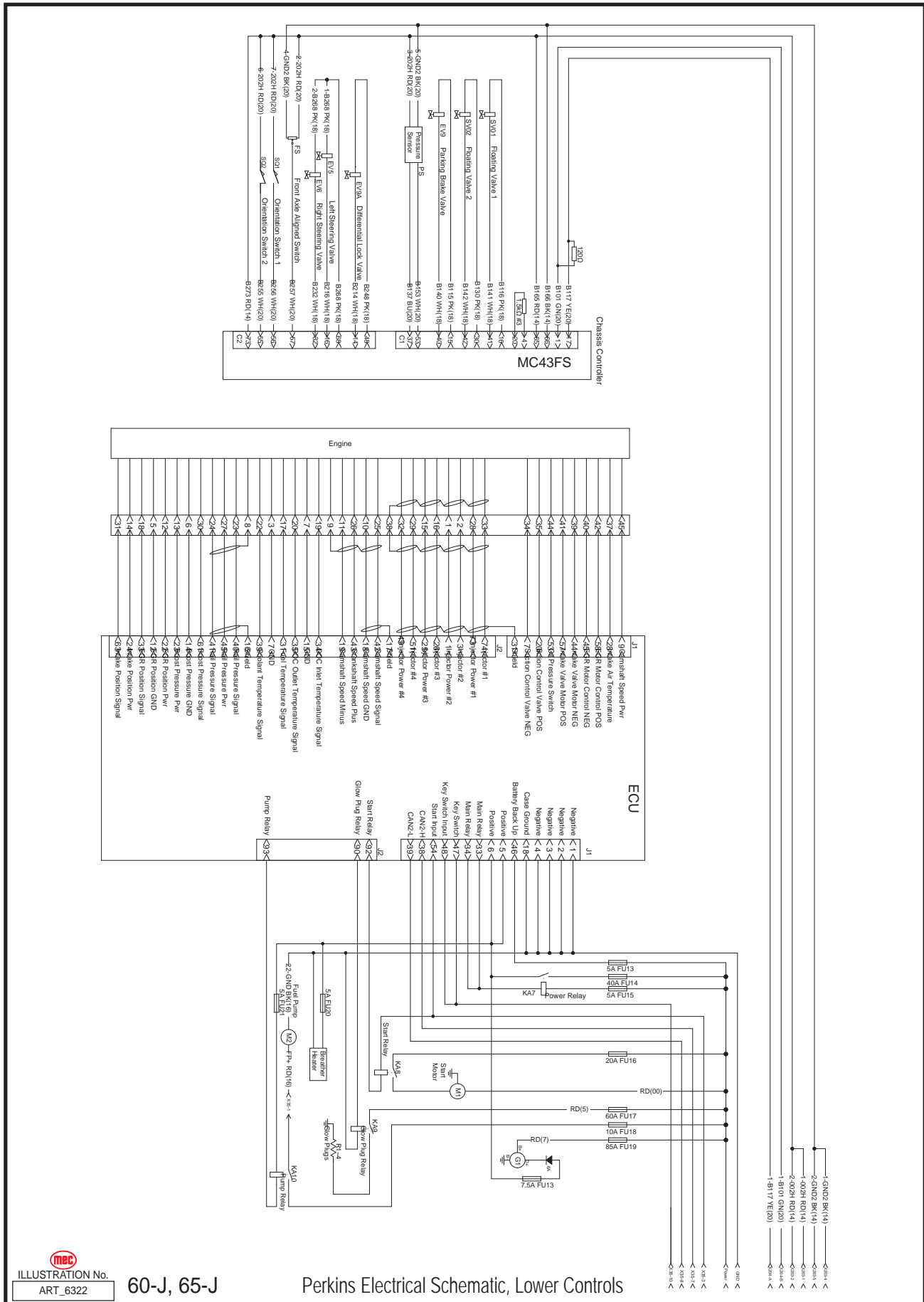

ILLUSTRATION No. ART\_6322

60-J, 65-J

Perkins Electrical Schematic, Lower Controls



# Electrical Schematic, Chassis, Perkins Engine

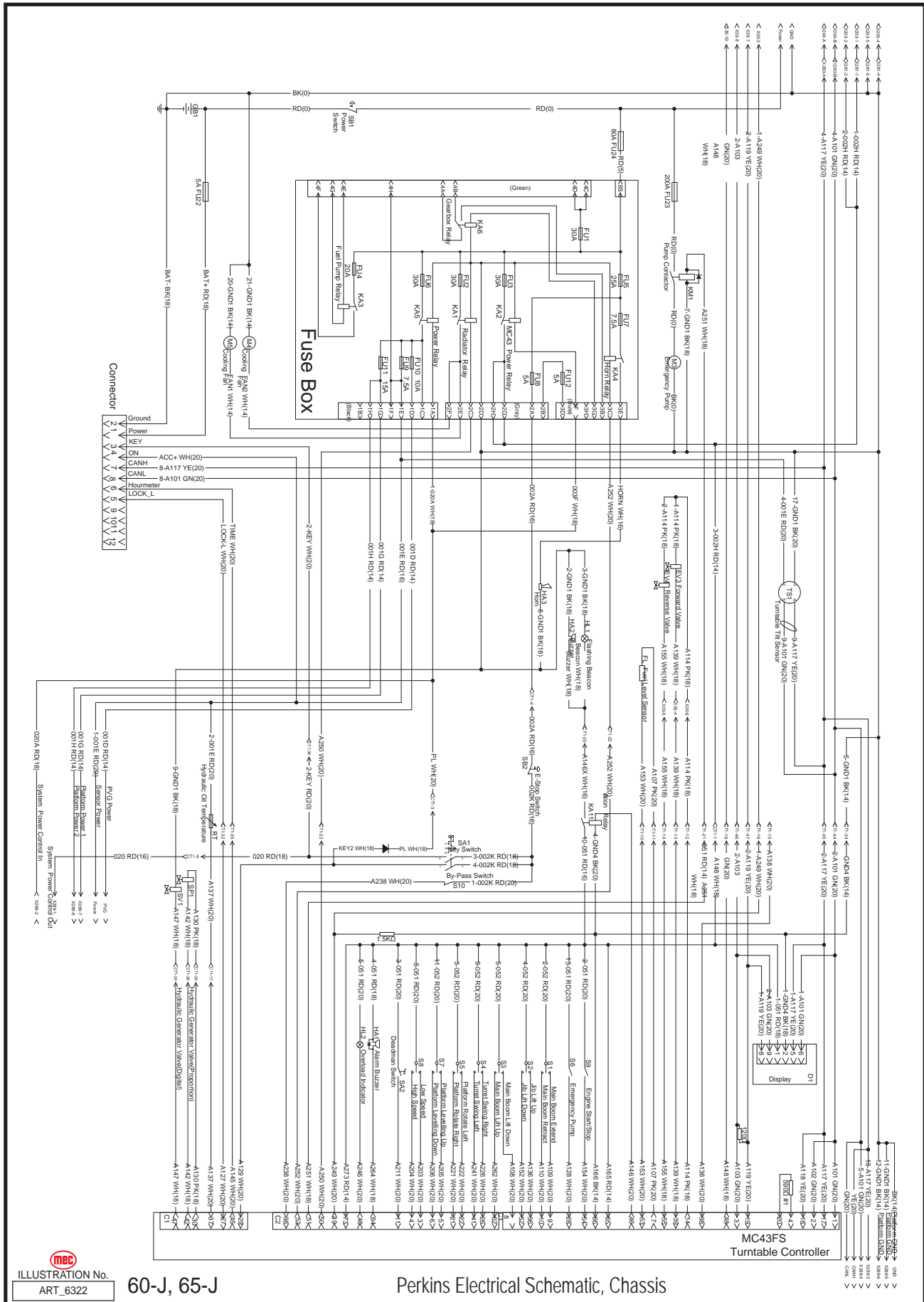

ILLUSTRATION No. ART\_6322

60-J, 65-J

Perkins Electrical Schematic, Chassis



# Electrical Schematic, Upper Controls, Perkins Engine

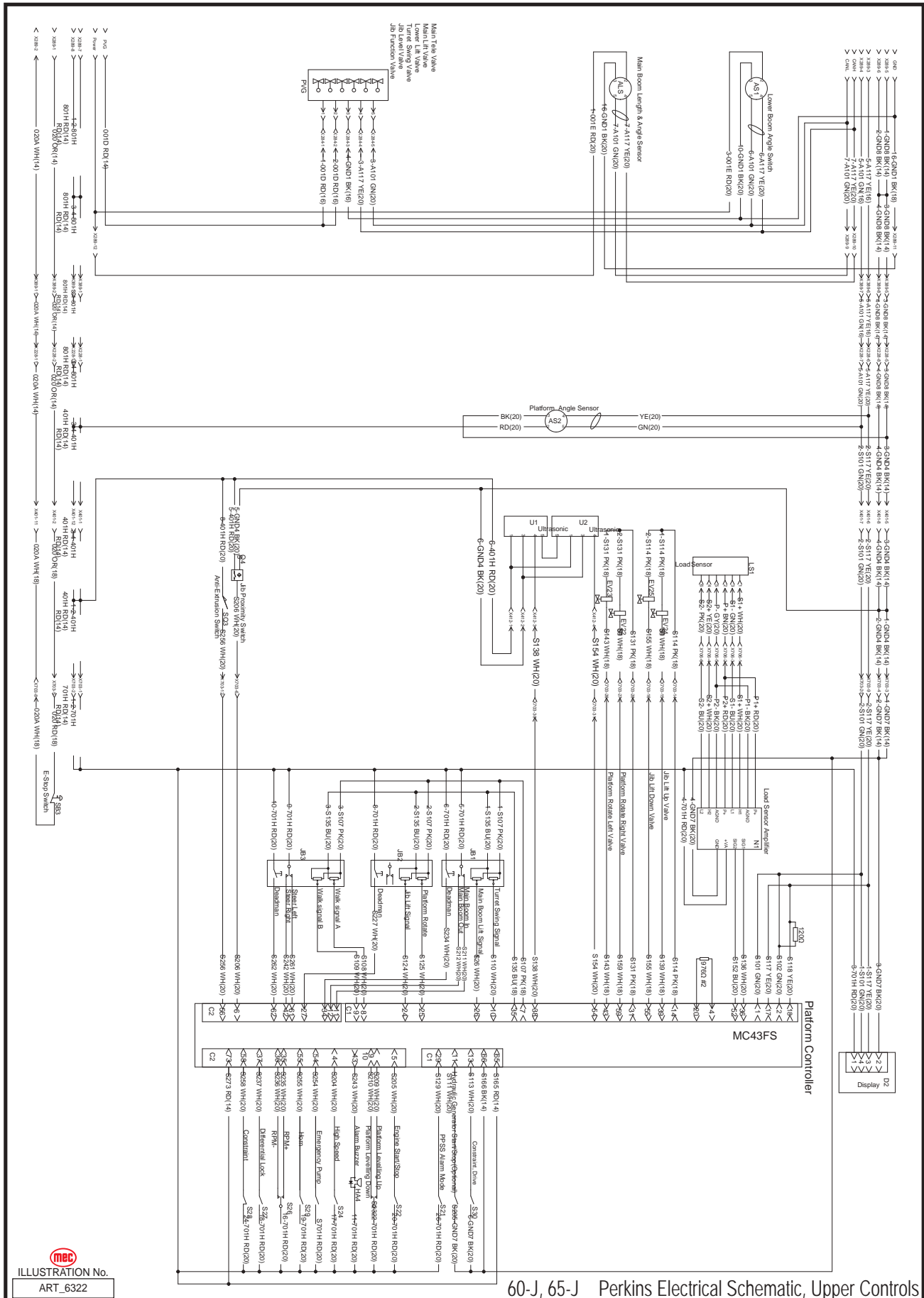

60-J, 65-J Perkins Electrical Schematic, Upper Controls



ILLUSTRATION No. ART\_6322

# Electrical Schematic, Lower Controls, Kubota Engine

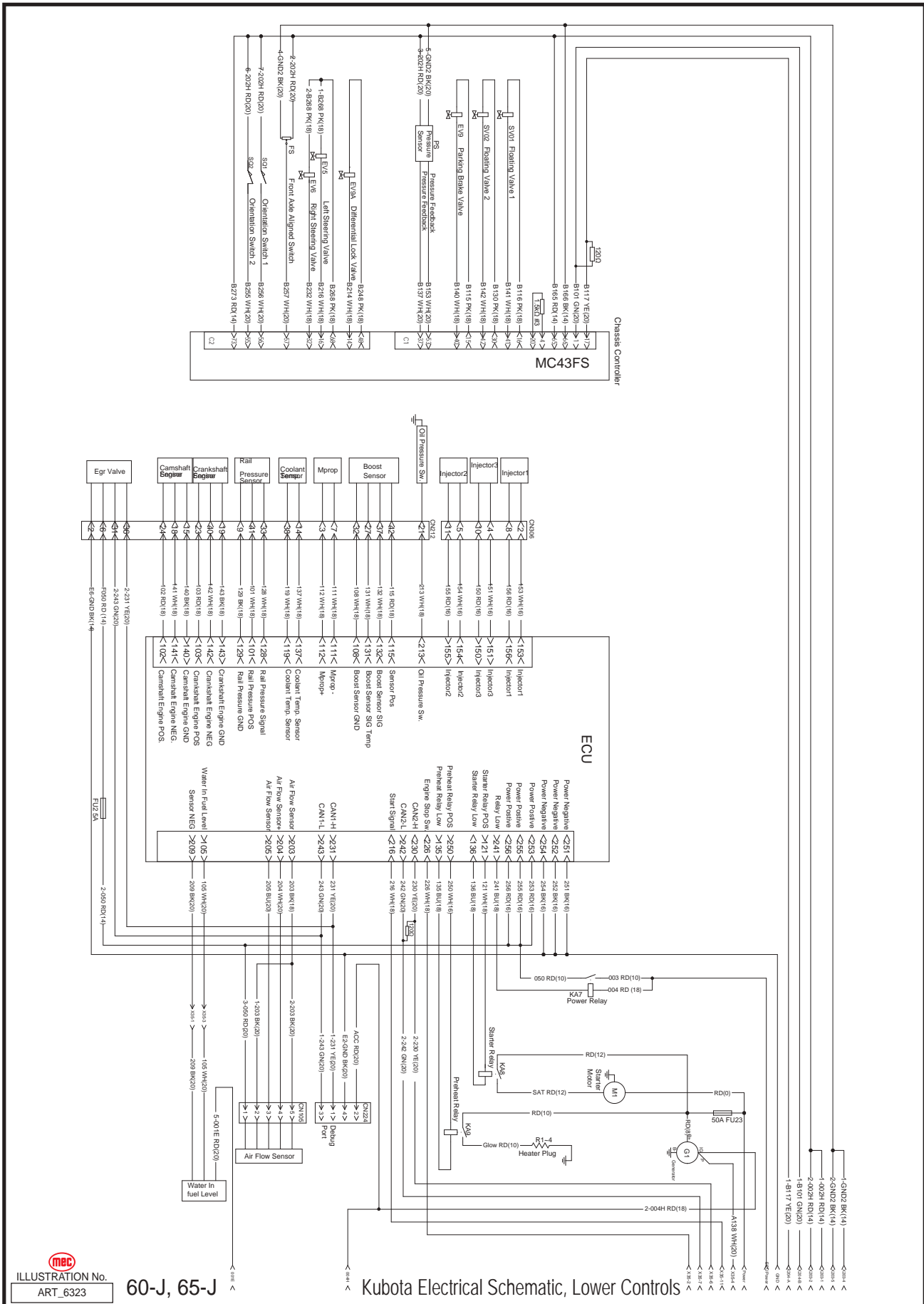

ILLUSTRATION No.  
ART\_6323

60-J, 65-J

Kubota Electrical Schematic, Lower Controls



# Electrical Schematic, Chassis, Kubota Engine

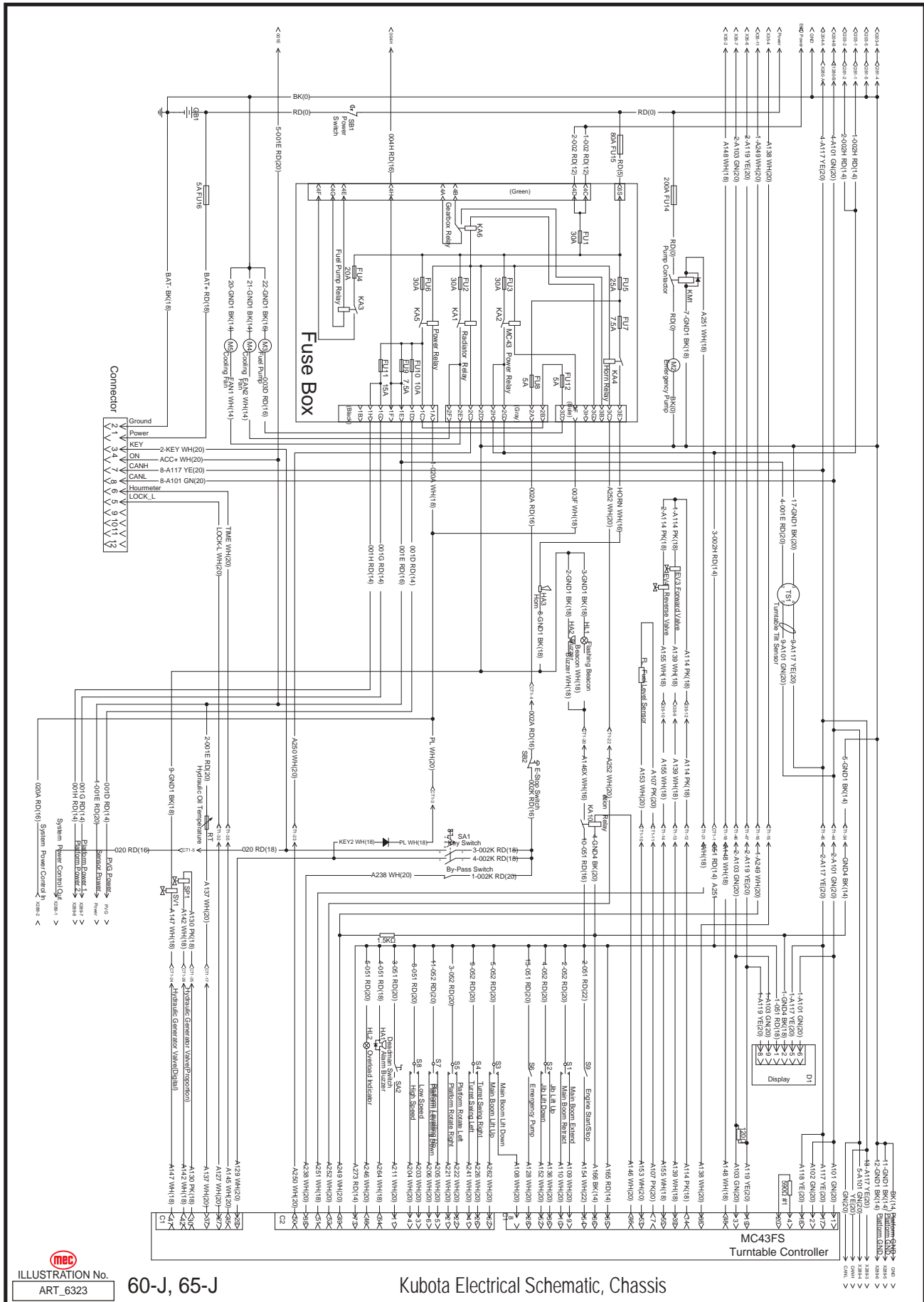

ILLUSTRATION No. ART\_6323

60-J, 65-J

Kubota Electrical Schematic, Chassis



# Electrical Schematic, Upper Controls, Kubota Engine

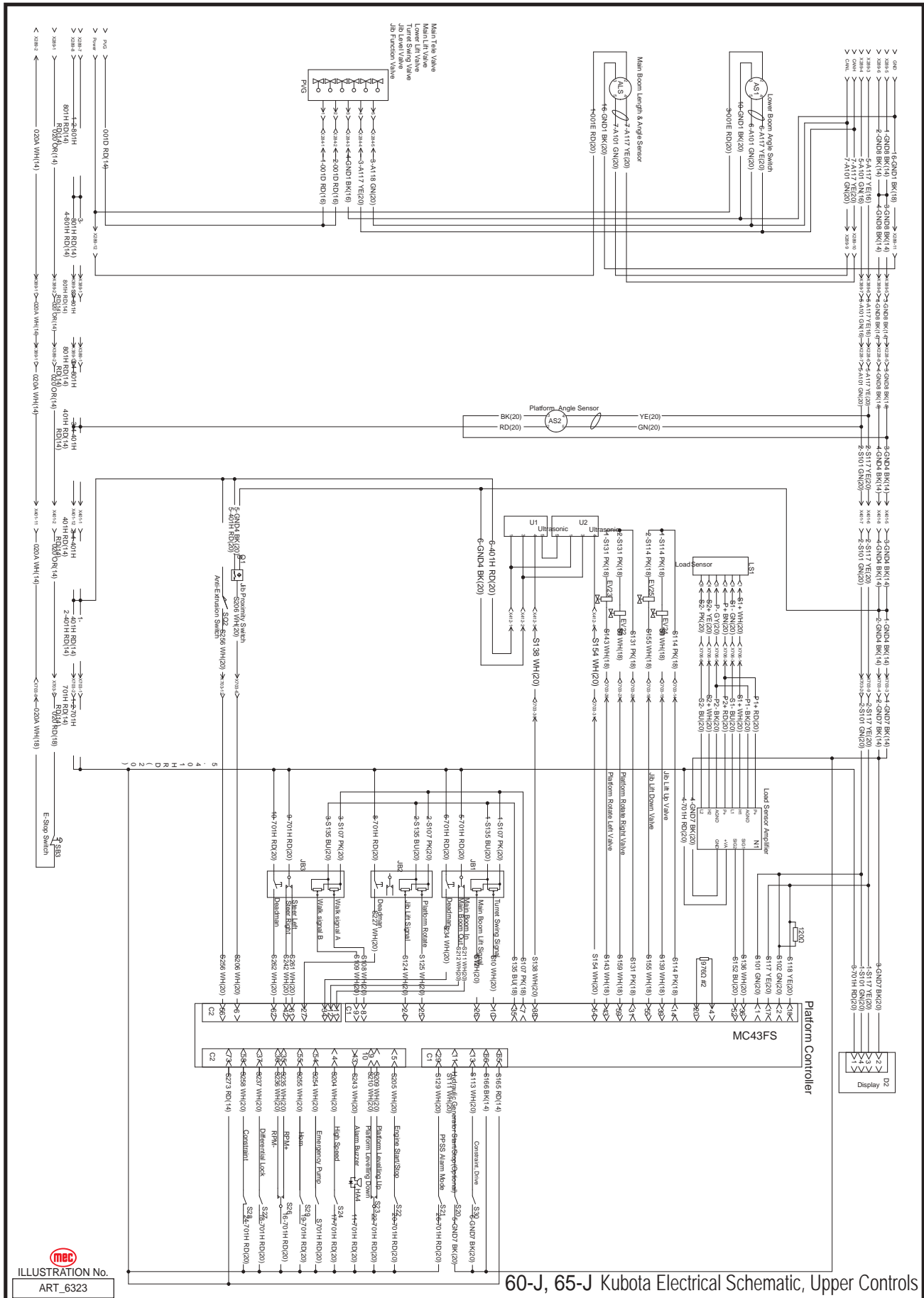

60-J, 65-J Kubota Electrical Schematic, Upper Controls



# Hydraulic Schematic, Part 1

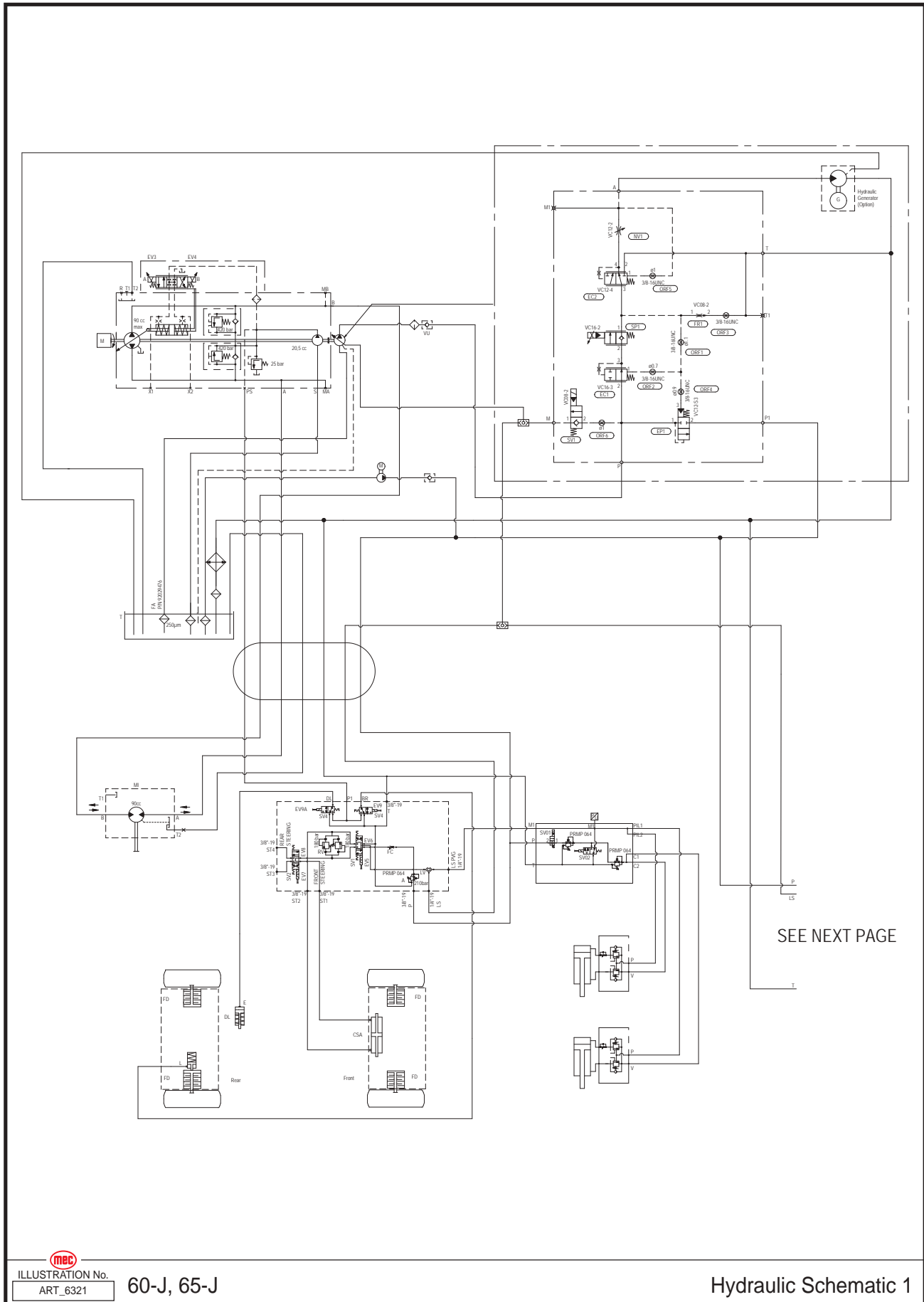

SEE NEXT PAGE



# Hydraulic Schematic, Part 2

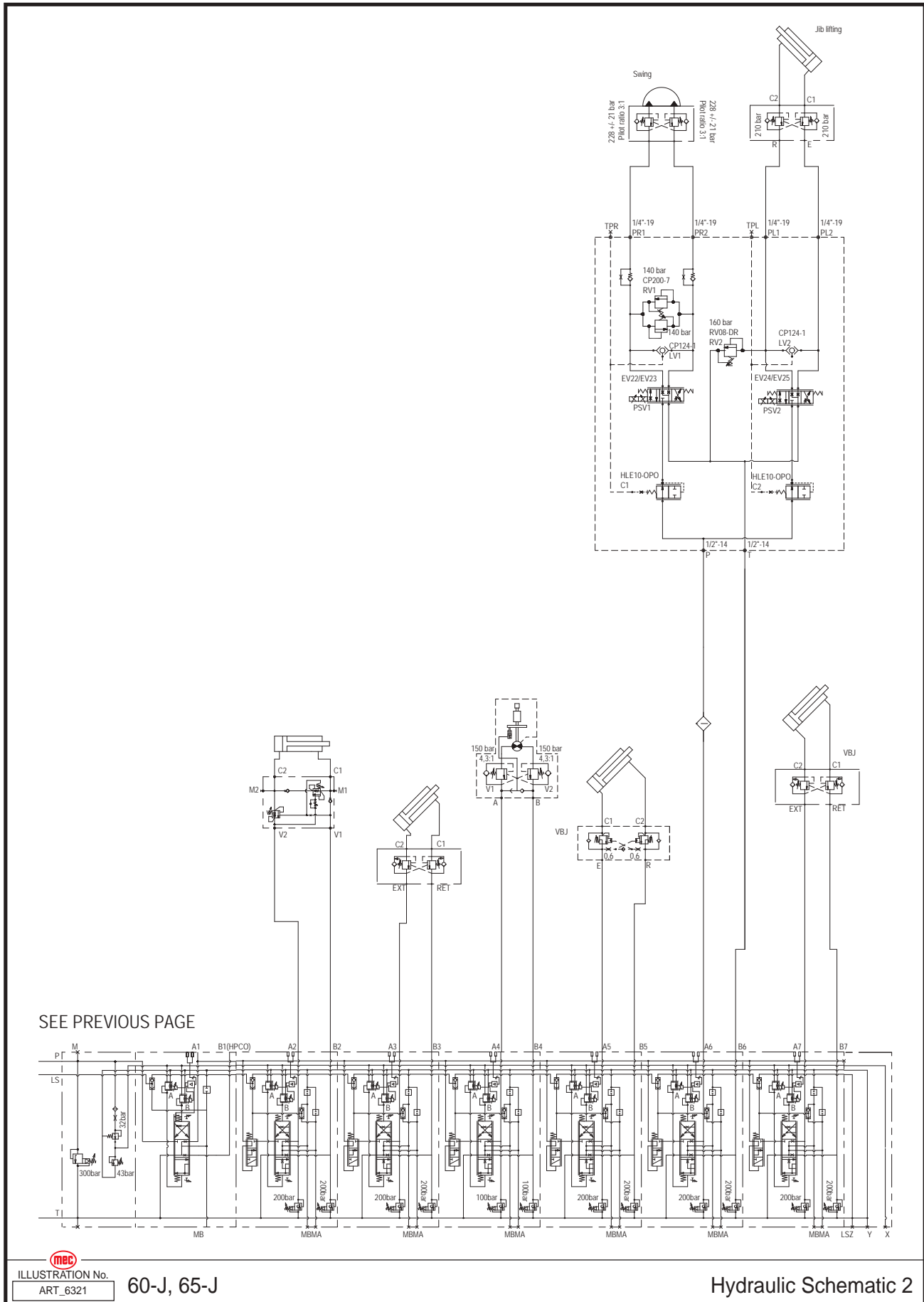

ILLUSTRATION No. **60-J, 65-J**  
 ART\_6321

Hydraulic Schematic 2